

Oxlife INDEPENDENCE



USER MANUAL

PORTABLE OXYGEN CONCENTRATOR

USER: READ THIS MANUAL BEFORE OPERATING THIS DEVICE. SAVE THIS MANUAL FOR FUTURE REFERENCE.

DEALER: THIS MANUAL MUST BE GIVEN TO THE END USER.



PROUDLY MADE IN THE U.S.A.

PLEASE READ THIS OPERATION MANUAL CAREFULLY BEFORE USING THIS DEVICE. BE AWARE OF ALL WARNINGS AND SAFETY INFORMATION. ONLY USE ACCESSORIES APPROVED BY O2 CONCEPTS AND REFERENCED WITHIN THIS MANUAL. IF YOU DO NOT FULLY UNDERSTAND ALL THE WARNINGS, SAFETY PRECAUTIONS, AND OPERATING INSTRUCTIONS CONTACT YOUR AUTHORIZED DEALER OR PROVIDER FOR TECHNICAL SUPPORT.

CAUTION: U.S. FEDERAL LAW RESTRICTS THESE DEVICES TO SALE BY OR ON THE ORDER OF A PHYSICIAN.

Table of Contents

Table of Contents





















Section 1: Introduction.....	9
Symbols Reference.....	9
How to Contact O2 Concepts.....	11
Specifications.....	12
Indications for Use.....	14
Dynamic Network Analysis.....	15
Section 2: Safety Guidelines.....	16
Device Safety Guidelines.....	16
Battery and Power Supply Safety Guidelines.....	18
Section 3: Product Description.....	19
Device and Accessories.....	19
Feature Identification.....	20
Understanding the Control Panel.....	21
Applied Parts.....	22
Section 4: Operating Instructions.....	23
Before Operating.....	23
Locating Your Device.....	24
Device Settings.....	25
Pulse Mode Bolus Volumes.....	26
Installing and Removing the Battery.....	27
Typical Battery Operation Times.....	27
Battery Time Management.....	28







AC Power Supply Home	29
DC Power Supply Auto	30
DC Power Supply Information Guide for Use	31
DC Power Supply Troubleshooting Guide for Use	32
Handling.....	34
Accessory Bag	35
Cannula Use	36
Humidifier Kit	37
Firesafe™ Cannula Valve	38
Entering and Exiting Airplane Mode	40
Accessing the Provider Screen and Changing Languages.....	42
Section 5: User Alerts and Alarms.....	45
Alarm and Alert Screens.....	45
Alarm System Test	46
How to Simulate Alarms and Alerts (Providers Only)	50
How to Respond to Alarms.....	54
Section 6: Maintenance and Cleaning.....	58
Maintenance	58
User Care and Cleaning.....	58
Air Inlet Filter Cleaning	58
Battery Disposal.....	60
Device Disposal.....	60
Section 7: Standards Compliance.....	61

NOTES..... 62

Section 1: Introduction

Symbols Reference

<u>Icon</u>	<u>Meaning</u>	<u>Icon</u>	<u>Meaning</u>
	On/Off Button		Use no grease or oils
	Mode Button		Type BF Equipment
	Continuous Mode		Do not dispose of in household waste
	Pulse Mode		Keep dry in transport and storage
	Breath Detect Icon		Not suitable for use in the presence of a flammable anesthetic mixture
	Increase Flow Setting		No smoking while using or near device
	Decrease Flow Setting		No open flames
	Battery Life Indication		Date of Manufacture
	AC/DC Power		Caution (as seen in manual)
	AC/DC Charging Indicator		Warning (as seen in manual)

<u>Icon</u>	<u>Meaning</u>	<u>Icon</u>	<u>Meaning</u>
	Do not disassemble		Auto (as seen in manual)
	Home (as seen in manual)	IP22	The Oxlife Independence protects against solid objects over 12mm and direct sprays of water up to 15° of vertical (IEC 60529)
	Refer to instructions		Contains Dynamic Network Analysis (DNA) technology
	Class II Equipment		

How to Contact O2 Concepts

Please contact your homecare provider if your Oxlife Independence requires service.

Please call O2 Concepts Technical Support, at 1-(877)-867-4008, for support with your Oxlife Independence. Please call Customer Service to report any unexpected operation and events associated with the device.

Information about the Oxlife Independence and O2 Concepts can also be found on our website at www.o2-concepts.com.

Specifications

DIMENSIONS	
Device Dimensions with Handle/Wheels	H: 20.29 in H: 51.5 cm W: 10.85 in W: 27.55 cm D: 9.45 in D: 24 cm
WEIGHTS	
Device Weight	16.7 lbs. (7.57 kg)
Cart Kit (Wheels & Pull Handle)	2.17 lbs. (0.98 kg)
Battery	1.4 lbs. (0.63 kg)
AC Charger	1.9 lbs. (0.86 kg)
DC Charger	.37 lbs. (0.16 kg)
MODES OF OPERATION	
Continuous Flow	0.5 to 3 LPM in 0.5 LPM increments; Measured flow values are within $\pm 2\%$ of actual values. Max flow 3.0 LPM. Flow maintained with outlet pressure ranging from 0 to 5.0 psig (0-34kPa)
Pulse Dose	0.5 to 6.0 (8mL-96mL) setting increments; Measured flow values are within $\pm 2\%$ of actual values
Battery Specification	14.4V Lithium Ion Battery
External Power Supply Power Input	AC power: 100 - 240 VAC, 50/60 Hz @ 2.5 amps DC power: 12-15 VDC; Recommended: 15A outlet at 12V
Altitude	0-13,123ft or (0-4000m)
Oxygen Purity	91% \pm 4% (87 - 95%) from 0.5 to 3.0 LPM; Measured purity values are within $\pm 2\%$ of actual values; There is no variation in purity within the operating altitude.
Operating Temperature	50°F (10°C) to 104°F (40°C)
Operating Humidity	10% - 95% @ 82.4°F (28°C)
Operating Atmospheric Pressure	101kPa to 63kPa
Operating Environment	Free of smoke, pollutants, and fumes.
Transport/ Storage Temperature	-4°F (-20°C) to 140°F (60°C)
Transport/ Storage Humidity	0 -95% non-condensing
Operating Time	24 hours per day when connected to an external AC or DC power source. This is a continuous operation device.
Cannula Specification	DO NOT use cannula tubing longer than 7ft (2.13m) when using Pulse Flow Mode Do NOT use cannula tubing longer than 50ft (15.25m) when using Continuous Flow Mode.
A-Weighted Sound Pressure Level	The volume that the device will reach at maximum settings will be ~ 56dBA with maximum peaks of 58.8dBA.
Alarm Sound Level	All alarms triggered by the device will be 85dBA at 10cm from the unit.
Maximum Outlet Pressure	Device will maintain flow up to 5psi back pressure. Maximum back pressure is 7.0psi.
Service Life	Device: 5yrs, Accessories: 1yr

Contraindications

- ⚠ Under certain circumstances, the use of non-prescribed oxygen therapy can be hazardous. This device should only be used when prescribed by a physician.

- ⚠ Not for use in the presence of aerosol sprays or flammable anesthetics.

- ⚠ Additional monitoring may be required for patients using this device who are unable to hear or see alarms or communicate discomfort.

- ⚠ The Oxlife Independence is not appropriate for any patient who would experience adverse health consequences as a result of a temporary interruption in oxygen therapy.

- ⚠ The availability of an alternate source of supplemental oxygen is strongly recommended in the case of power interruption or a mechanical failure of the device.

- ⚠ This device is for adult use only. It is not qualified for use by pediatric patients.

Indications for Use

- ⚠ PRESCRIBED MODE AND FLOW SETTINGS SHOULD ONLY BE ADJUSTED UNDER THE ADVICE OF A PHYSICIAN
- ⚠ The O2 Concepts Oxlife Independence is indicated on a prescription basis for the administration of supplemental oxygen. It is not intended for life support, nor does it provide any patient monitoring capabilities.
- ⚠ Federal law restricts this device to sale by or on the order of a physician.
- ⚠ No modification of this equipment is allowed.

There is no know interference posed by ME equipment during specific investigations or treatments.

There are no known devices that will cause interference issues.

Dynamic Network Analysis

This version of the Oxlife Independence contains Dynamic Network Analysis (DNA) technology that allows your health care provider to better serve your needs. This technology will allow your provider to ensure that your device continues to operate within specification.

The cell must be deactivated prior to flight on a commercial aircraft.

Instructions for deactivating the cell are listed on page 39 and 40 within the Section: Entering and Exiting Airplane Mode.

Device is FAA approved for use aboard passenger aircraft (FAA Advisory Circular 91.21-1B), including radio frequency emission limits of (RTCA) Document (DO) 160. section 21. Category M. Device contains FCC Id R5Q-LISAC200A.













Section 2: Safety Guidelines

Device Safety Guidelines

- ❗ Avoid exposure to open flames or creation of any spark near your Oxlife Independence. This includes sparks from static electricity created by any type of friction. Protect electrical power cords from sharp edges to avoid electrical shock and serious physical injury.
- ❗ Locate the Oxlife Independence in a well ventilated area to allow for adequate air intake. Avoid the intake of airborne pollutants, smoke, or fumes.
- ❗ Use only approved accessories as specified in this User Manual. Use of non-approved accessories may cause serious damage to the device and will void the warranty.
- ❗ Locate oxygen tubing and power cords away from hot surfaces and in a manner to prevent tripping hazards.
- ❗ DO NOT operate the device in an enclosed space, such as a closet.
- ❗ DO NOT block the air inlet or the exhaust vents located on the side of the device.
- ❗ DO NOT cover the device with a towel, blanket, etc.
- ❗ DO NOT drop or insert any objects or liquid into any opening.
- ❗ DO NOT leave your Oxlife Independence or batteries in your vehicle or trunk. Extreme hot or cold may damage your device and or batteries.
- ❗ DO NOT ship the Oxlife Independence with the batteries installed. Batteries must be shipped separately and packaged appropriately.

Device Safety Guidelines

-  DO NOT SMOKE WHILE USING THIS DEVICE. KEEP ALL MATCHES, LIT CIGARETTES, CANDLES, OR OTHER SOURCES OF IGNITION AT LEAST 10 FEET FROM THE DEVICE. THIS DEVICE PRODUCES ENRICHED OXYGEN GAS WHICH ACCELERATES COMBUSTION.
-  Outdoor use must be conducted using battery power.
-  Keep unit away from children, pets, and potential house hold pests.
-  Use caution when operating with long power cords or cannulas due to possibility of strangulation from excess length.
-  Use caution as small parts may pose a choking hazard.
-  Do not remove any parts or fasteners from unit. Small parts can cause injury if inhaled or swallowed.
-  DO NOT use the device with a damaged power cord or plug.
-  DO NOT operate the device on wet surfaces or in standing water, and do not submerge or expose to water. If the Oxlife Independence has been dropped, damaged or exposed to water please contact your authorized dealer for inspection and possible repair of the device.
-  DO NOT come in contact with the device when wet.
-  DO NOT use oil, grease, or petroleum based products on or near the device.
-  DO NOT use the device with an extension cord.

Battery and Power Supply Safety Guidelines

- ⚠ Use of non-approved battery or power supply may cause serious damage to the device and will void the warranty.
- ⚠ Store the battery in a cool dry place when not in use.
- ⚠ Remove the battery from the device if it will not be used for an extended period of time.
- ⚠ Locate the external power supply in the open air to prevent overheating when in use.
- ⚠ U.S. Department of Transportation (DOT) and United Nations (UN) regulations require that batteries be removed from the device when checked as luggage on international flights.
- ⚠ The battery may explode if exposed to or disposed of in a fire.
- ⚠ Use only the supplied battery, AC and/or DC power supplies that were provided with the device.
- ⚠ Keep the battery away from children.
- ⚠ Use of a damaged battery or power supply may cause personal injury.
- ⚠ DO NOT attempt to disassemble the battery or power supply.
- ⚠ DO NOT short circuit the battery's metal contacts with metallic objects such as keys or coins. It may cause sparks or excessive heat.
- ⚠ DO NOT use the battery or power supply for anything other than its intended purpose.
- ⚠ DO NOT drop the battery or expose it to mechanical shock.
- ⚠ DO NOT expose the battery to water or other liquids.
- ⚠ DO NOT expose the battery to excessive heat or cold.

Section 3: Product Description

Device and Accessories

Information regarding how to operate the Oxlife Independence and its accessories can be found in the following sections: Product Description and Operating Instructions.

- ⓘ The use of certain humidifiers and administration accessories not specified for use with this oxygen concentrator may impair performance.

Accessories for the Oxlife Independence:

- Battery
- Battery Shell/Blank
- Desktop Charger (Single Bay)
- Desktop Charger (Dual Bay)
- Desktop Charger (6 Bay)
- AC Power Supply
- DC Power Cord
- Accessory Bag
- Humidifier Kit
- 7ft Cannula
- 50ft Cannula
- Firesafe™ Cannula Valve

Feature Identification

1. Control Panel
2. LCD Display
3. Oxygen Outlet Port
4. Exhaust Port
5. Wheels
6. Rechargeable Battery Slots
7. FAA Approval Identification
8. Pull Handle
9. Air Intake Port Filter
10. External Power Input
11. Handle Lock / Release Button
12. Carry Handle

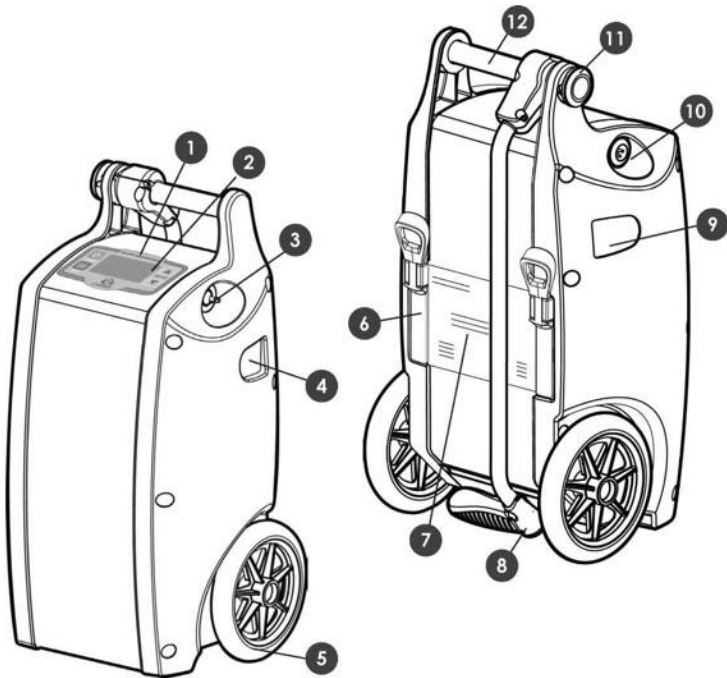

Understanding the Control Panel

13. Power Button
14. Battery Status
15. External Power Source / Battery Charging Indicator
16. Increase / Up Button
17. Decrease / Down Button
18. System Status
19. Breath Detect (Pulse Mode Only)
20. Mode Setting
21. Mode Button

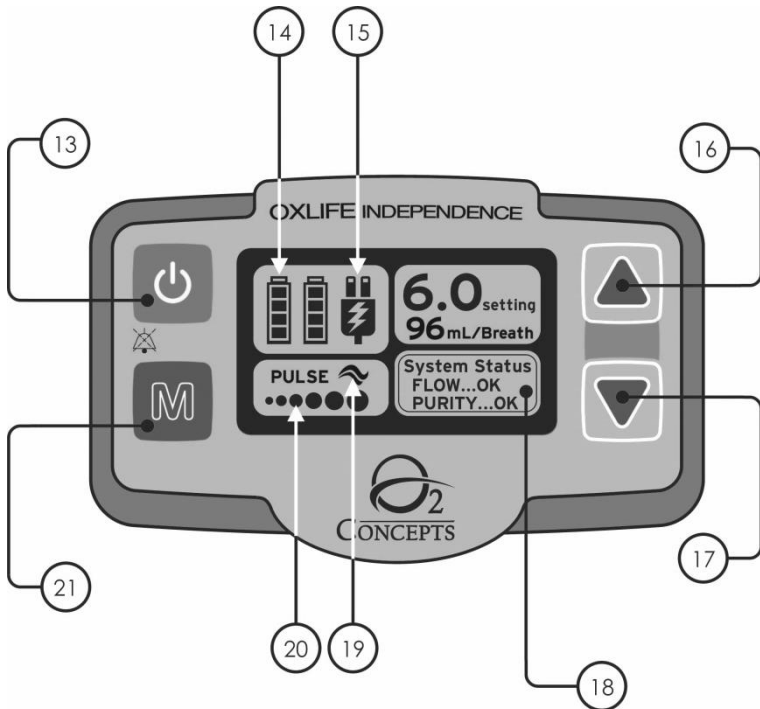

Applied Parts

The applied parts, or components that a patient will come in contact with during normal operation of the device, are listed below:

1. Handle
2. Display
3. Oxygen Port



Section 4: Operating Instructions

Before Operating

Your authorized dealer will and or should demonstrate proper operation of your Oxlife Independence. This manual should be saved for future reference to help you safely operate your device. If you have any further questions please contact your authorized dealer.

This equipment needs to be installed and put into service in accordance with the information provided in the accompanying documents.

DO NOT operate the Oxlife Independence without first reading the Safety Guidelines included in SECTION 2 of this manual.

Please follow all operating instructions.

If you are relocating your Oxlife Independence from an extreme environment, allow the device to return to the specified operating temperature and humidity ranges before use.

Operating your device outside of specified ranges may damage your device, impact device performance and may void your warranty. See Operating Temperature and Humidity Ranges listed in the Specification Table.

Fully charge batteries before first use.

Locating Your Device

Place the Oxlife Independence in a well ventilated area free of smoke, fumes, pollutants, and away from direct sun light. Avoid high humidity environments.

Ensure that air intake and exhaust ports are not obstructed.

The Oxlife Independence MUST be located so that alarms can be heard.

Position the oxygen supply tubing and power cords in a manner that prevents kinking, air flow obstructions, and tripping hazards.

To protect device finish, it is recommended to use the Oxlife Independence in either an upright position or lying on its back.

DO NOT operate the device in an enclosed space, such as a closet.

DO NOT locate the Oxlife Independence near any flammable materials or cleaning product or in the direct path of any heat source such as a stove, heat register or a car heater. Keep the Oxlife Independence at least 5 feet (1.6m) from hot sparking objects or open flame.

Device Settings

Turn the device on by pressing the Power Button .

Press the Mode Button  to select Continuous or Pulse Flow Mode.

Press the Increase  or Decrease  buttons to select the correct flow rate.

Turn the device off by pressing and holding the Power Button .

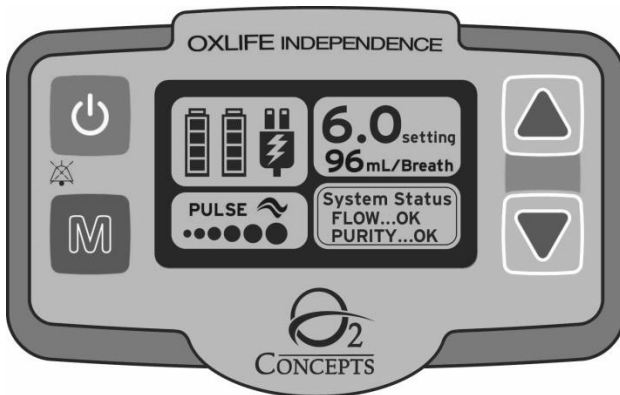

THE PROPER FLOW MODE AND FLOW RATE ARE PRESCRIBED BY YOUR PHYSICIAN. DO NOT CHANGE THESE SETTINGS WITHOUT CONSULTING WITH YOUR PHYSICIAN.

PULSE FLOW MODE SHOULD ONLY BE USED UNDER THE DIRECTION OF YOUR PHYSICIAN. APPROPRIATE AND SAFE PULSE MODE SETTINGS MUST ACCOMMODATE THE INDIVIDUAL PATIENT'S LIFESTYLE INCLUDING REST, TRAVEL AND EXERCISE.

The device may take up to 3 minutes in order to warm up and reach desired performance.



CONTINUOUS FLOW MODE

In Continuous Flow Mode a continuous flow of oxygen will flow through the cannula and into your nose. The oxygen is measured in Liters per Minute or LPM.



PULSE FLOW MODE

In Pulse Flow Mode the device will detect your breath and supply a measured pulse of oxygen or bolus. The breath detect icon will flash on the control panel with each breath.

At higher flow settings, you may notice the motor revving which is normal and necessary to achieve maximum oxygen output.

Pulse Mode Bolus Volumes

Pulse Mode Setting	Bolus Volume (mL)
0.5	8
1.0	16
1.5	24
2.0	32
2.5	40
3.0	48
3.5	56
4.0	64
4.5	72
5.0	80
5.5	88
6.0	96

If no breath is detected for 45 seconds, the display screen will turn amber, and the device will beep once. If no breath is detected for an additional 15 seconds, the device will default to the previous continuous flow mode setting.

Installing and Removing the Battery

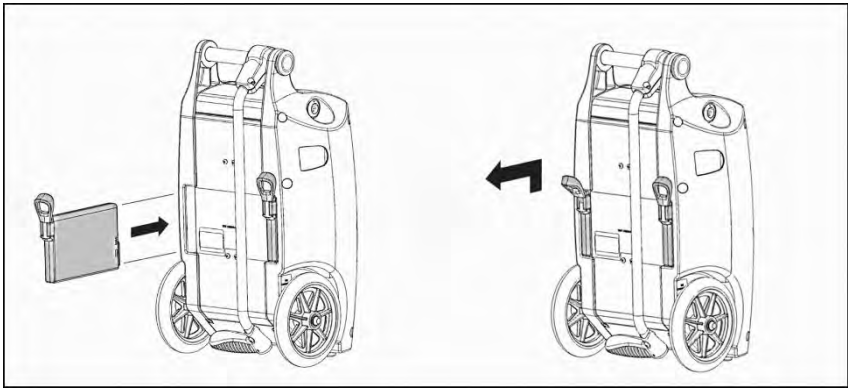

INSTALL	REMOVE
SLIDE INTO BACK OF DEVICE; BATTERY WILL DROP DOWN SLIGHTLY AND CLICK INTO POSITION	PULL TAB AWAY FROM UNIT; LIFT BATTERY UP SLIGHTLY; THEN SLIDE STRAIGHT OUT

Typical Battery Operation Times

(@ 20 Breaths/Minute)

FLOW RATE SETTING	CONTINUOUS FLOW (Hours of Battery Life)		PULSE FLOW (Hours of Battery Life)	
	1 Battery	2 Batteries	1 Battery	2 Batteries
0.5	2hr 53 min	5hr 45min	3hr 8 min	6hr 15min
1.0	2hr 38 min	5hr 15 min	3hr	6hr
1.5	1hr 45 min	3hr 30 min	3hr	6hr
2.0	1hr 15 min	2hr 30 min	2hr 53min	5hr 45min
2.5	1hr	2hr	2hr 23min	4hr 45min
3.0	45 min	1hr 30min	2hr	4hr
3.5	N/A		1hr 45min	3hr 30min
4.0			1hr 30 min	3hr
4.5			1hr 15min	2hr 30min
5.0			1hr 8min	2hr 15min
5.5			1hr	2hr
6.0			53min	1hr 45min

OPERATING TIME WILL DEGRADE WITH BATTERY USE AND AGE.

Battery Time Management

With the combined use of the battery, AC power supply, and DC power cord your time away from home is virtually limitless. Using the AC and DC power cords whenever possible will give you optimal battery life. The battery will charge in the device, when plugged into an external power source.

The Oxlife Independence comes equipped with a rechargeable lithium battery that is NOT user serviceable.

Battery Charge Status is also displayed on the control panel. Each bar represents approximately 25% of the total battery charge. When the battery is fully charged (over 90%) the battery icon will appear solid.

The Oxlife Independence battery includes a battery charge status indicator located on the front of the battery. Simply press the "PUSH" button on battery to display the remaining battery life in 25% increments.

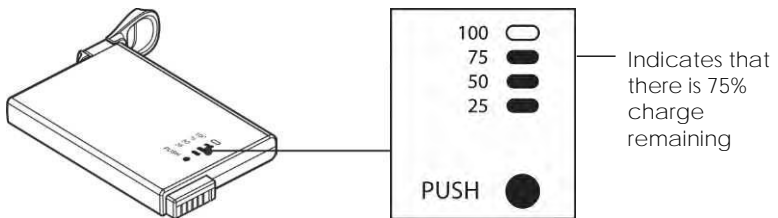

The typical time to recharge a fully discharged battery is approximately 1.5 hours if charging a single battery and 2.5 hours if charging two with the device plugged into the AC power supply and powered off. Battery Charge times with the device running will vary depending on setting used.

There is no routine maintenance or service to the O2 Concepts rechargeable batteries.

AC Power Supply Home

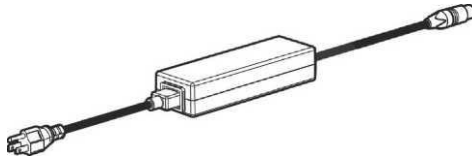

ⓘ Use only the power supplies provided with this device.

The AC power supply charges the battery using a 100-240 volt 50/60 Hertz outlet (a typical wall outlet in your home). Using the AC power supply allows you to use your Oxlife Independence while simultaneously recharging the battery.

To use the AC power supply, connect the power supply to a wall outlet and the Oxlife Independence. The external power icon will be displayed on the control panel.

Recommendation for Use:

Use no electrical outlets controlled by a switch.

When changing power sources wait for the control panel to display the new power icon and unit to beep before removing the original source.

The detachable power supply cord to the power supply is the means of isolating the unit from the supply mains.

If the AC power supply is removed from the device, wait 10 seconds before re-applying power.

When traveling internationally a standard international power plug adapter is all that is required.

EXTERNAL POWER INPUT

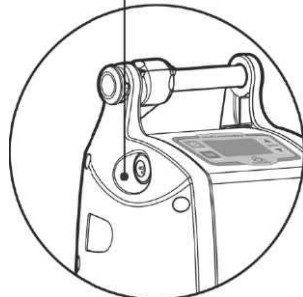

DC Power Supply Auto



- ❗ Use only the power supplies provided with this device.
- ⚠ The DC power cord allows you to power your Oxlife Independence from your vehicle's (car, boat, RV) 12/15 volt DC outlet, (cigarette lighter) in all settings. Use the DC outlet closest to the battery. Use no other DC outlets in the vehicle. If your vehicles DC power drops to 11.6 volts or below, the device will revert to battery power. A 15 amp outlet at 12 volts is recommended for use with the device.
- ⚠ The external power icon will be displayed on the control panel.

Recommendations for Use:

- ⚠ ALWAYS have the vehicle's engine running before plugging in your Oxlife Independence. With the engine running, plug in and turn on your device.
- ⚠ When operating the Oxlife Independence in your vehicle, ensure that the device is securely stowed and will not get damaged during transport.
- ⚠ Ensure that air inlet and exhaust ports are not blocked.
- ⚠ Batteries will not charge at any setting if the engine is not running.
- ⚠ DC power is not sufficient to charge the batteries at all settings. Charging will NOT occur at settings higher than Continuous 2.0 or Pulse 4.0.
- ⚠ The device may "rev" more while operating on DC power. This is normal operation while connected to DC power and not cause for any concern.
- ⚠ DO NOT leave the device plugged into the vehicle when the engine is not running.
- ⚠ DO NOT use the Oxlife Independence with any power splitting devices.

DC Power Supply Information Guide for Use

Starting the Device on DC Power

1. **Be sure that the vehicle's engine is running PRIOR** to plugging in your Oxlife Independence.
2. Plug DC power cord into the device before plugging into the vehicle's DC outlet.
3. Plug DC power cord into the vehicle's DC outlet.
4. Remove the DC power cord from the vehicle's DC outlet when the engine is not running.

Stopping the device on DC power

1. Without batteries installed, keep the vehicle's engine running and power the device Off by pressing and holding the power button.
2. When the device is Off, disconnect the DC power cord from the vehicle's DC outlet.
3. With batteries installed, disconnect the DC power cord from device. The device will beep once and switch to internal battery power.

To Reset / Reboot

1. With batteries installed, remove DC power from the device and wait 15 seconds.
2. Remove the batteries from the device.
3. Re-insert the DC power cord into the device.
4. Turn device On using the power button.

DC Power Supply Troubleshooting Guide for Use

<u>Event</u>	<u>Solution</u>
Batteries Not Charging	<ul style="list-style-type: none"> • If there is no charging icon (lightning bolt symbol), reduce the device setting to 0.5LPM Continuous and wait for charging icon to appear. • Next, increase the flow rate by 0.5 increments until desired flow rate is reached. (Batteries will not charge on settings higher than 2.0 Continuous or 4.0 Pulse)
Low Battery Alarm	<ul style="list-style-type: none"> • If batteries are fully depleted to 0%, they may not charge until the device is powered off. Batteries may require being charged to 10% in order for the lightning bolt to appear on the display. • To prevent accidental discharge of fully charged batteries, batteries can be removed from the device while running on DC power.
Device Alerting / Beeping Intermittently	<ul style="list-style-type: none"> • If the DC power drops equal to or below 11.6 volts, the device will beep. • If batteries are installed, the device will switch to battery power. • The device will automatically return to DC power once the vehicle supplies the proper voltage. The device will default to the most reliable source of power to supply oxygen.
Unit Not Running	<ul style="list-style-type: none"> • Perform a Reset/Reboot
Low External Power Alarm	<ul style="list-style-type: none"> • There may be too much of a power draw on the vehicles electrical system (ie: air conditioning, radio, or GPS). Try eliminating these power draws. • Check your vehicle's user manual or consult an auto technician to determine your vehicle's DC power amperage and wattage. The device requires 150 watts (15 amps) to run at all settings. • You may require an Inverter with at least a 450 watt capacity. This can be purchased through any Auto Service Provider.

Handle Operation

OPEN/CLOSE

Press button to unlock handle.

Begin rotating and release button.

Handle will re-lock in open/close position automatically.

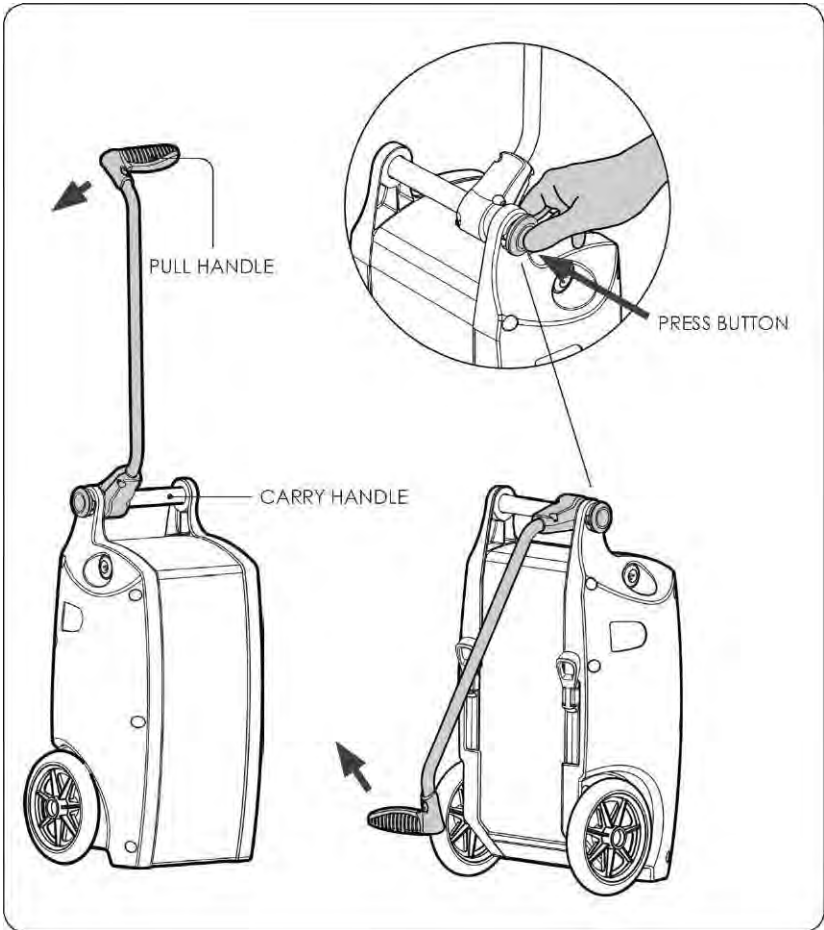

Handling

⚠ DO NOT LEAN ON UNIT

To prevent damage to the unit, avoid resting excessive weight on handle.



⚠ STAIRS

While transporting the unit down stairs, it is recommended to allow unit to travel down first.

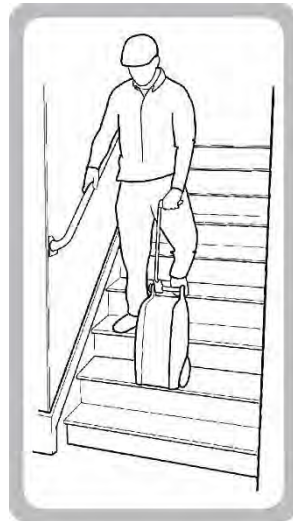

Accessory Bag

The Accessory Bag is designed to carry your Oxlife Independence accessories including batteries, AC charger and cable, and DC charger.

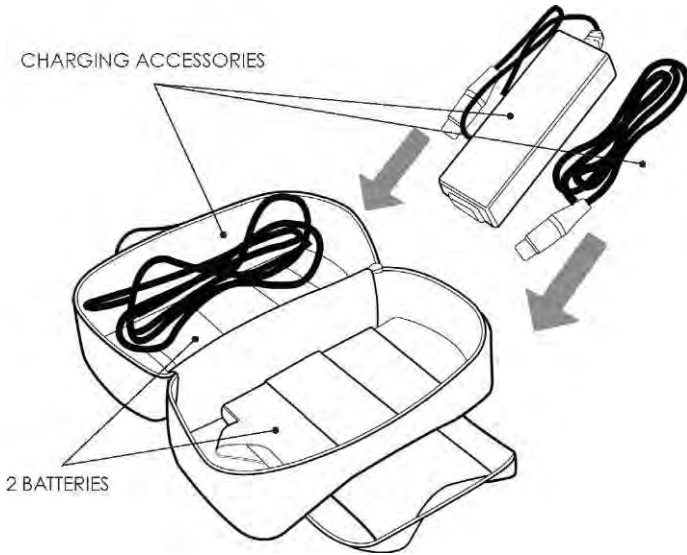

Cannula Use

- ⚠ Your physician or dealer will recommend the proper cannula for your use
- ⚠ Use of a cannula not specified for use with oxygen may impair the performance of your device.
- ⚠ DO NOT use cannula tubing longer than 7 feet when using Pulse Flow Mode.
- ⚠ DO NOT use cannula tubing longer than 50 feet when using Continuous Flow Mode. Your physician will prescribe the appropriate cannula for your use.

Connect the cannula to the oxygen outlet port as shown on adjacent page. The cannula fitting may be tight.

DO NOT use grease or oils to lubricate the oxygen outlet port.

Read and follow the instructions included with the cannula, and follow the instructions given by your authorized dealer.

Place the cannula over your ears and position the cannula prongs in your nose.

Clean and replace your cannula regularly as instructed by your authorized dealer.

O2 Concepts recommends M125310 from Salter Labs, or equivalent, as a 7ft cannula and 1650HF-50-10 from Salter Labs, or equivalent, as a 50ft cannula.

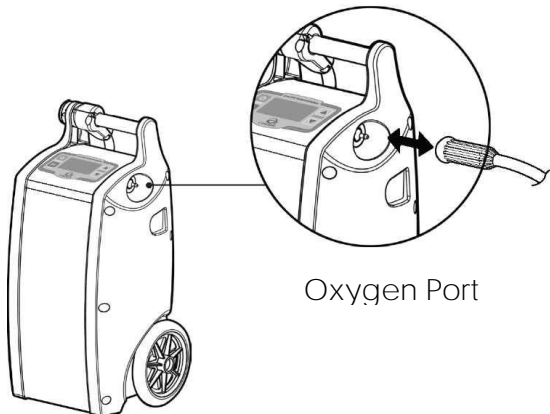

Humidifier Kit

The O2 Concepts Oxlife Independence portable oxygen concentrator is designed to be used with a humidifier bottle in continuous flow mode only. Use of this Device with a humidifier in pulse mode may impair performance and/or damage your device. DO NOT overfill humidifier. Fill the humidifier with distilled water only to the level shown by the manufacturer of the humidifier bottle.

DO NOT reverse the oxygen input and output connections. Water from the humidifier will travel through the cannula and back to the patient.

DO NOT operate your O2 Concepts Oxlife Independence and ambulate while a humidifier is attached. Always remove the humidifier before walking.

DO NOT lay your device down horizontally while attached to a humidifier.

Using the Humidifier:

O2 Concepts recommends using the 800-1015 Humidifier Bottle Strap to attach your humidifier to your oxygen concentrator.

1. Raise the Oxlife Independence handle, slide the humidifier strap on unit, pull it down until tight, and buckle the bottom strap.
2. Place the humidifier bottle into the front pocket.
3. Install the tubing to the top of the humidifier bottle.
4. Connect the other end of the tubing to the oxygen output connector on the Oxlife Independence.
5. Install the cannula to the output port on the humidifier bottle.

Refer to the 800-1015 Humidifier Bottle Adapter Assembly Instructions for additional direction descriptions and troubleshooting help.

Cleaning the Humidifier:

Note: To clean the humidifier, follow the instructions provided by the manufacturer. If none are provided, follow these steps:

1. Clean the humidifier daily.
2. Wash it in soapy water and rinse it with a solution of ten parts water to one part vinegar.
3. Rinse thoroughly with hot water.

Replace the humidifier monthly or as recommended by the manufacturer or your authorized dealer.

Purchase of humidifier bottle and cannula equipment should be purchased through your oxygen provider.

O2 Concepts recommends the use of the 7100-0-50 humidifier from Salter Labs or equivalent.

Firesafe™ Cannula Valve

Intended Use:

The Firesafe™ Cannula Valve is a thermal fuse designed to extinguish an oxygen delivery tube fire and stop the flow of oxygen if the tube is accidentally ignited.

-  Read Firesafe™ Cannula Valve Instructions before installing. As with all medical equipment, attempting to use or install this device without a thorough understanding of its operations and limitations may result in patient or user injury.

The device is intended for a life of 4 years from the manufacturing date stated on the device label.

The Firesafe™ Cannula Valve must be used in order to comply with IEC 60601-1 and ISO 8359.

Refer to Instructions for Use for Part Number: 1109-2017 CE from Applied Home Healthcare Equipment. This includes intended use, warnings, installation instructions, cleaning, maintenance, disposal, and device specifications.

Entering and Exiting Airplane Mode

The cell must be deactivated prior to flight on a commercial aircraft.

To enter and exit airplane mode, follow the steps listed in the procedure below.

Step 1:

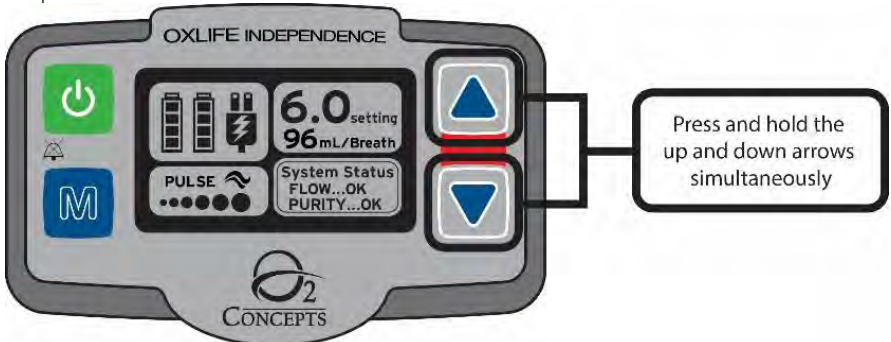

Press and hold both the Up Arrow Button (▲) and Down Arrow Button (▼) simultaneously in order to enter the Service Mode screen.

Step 2:

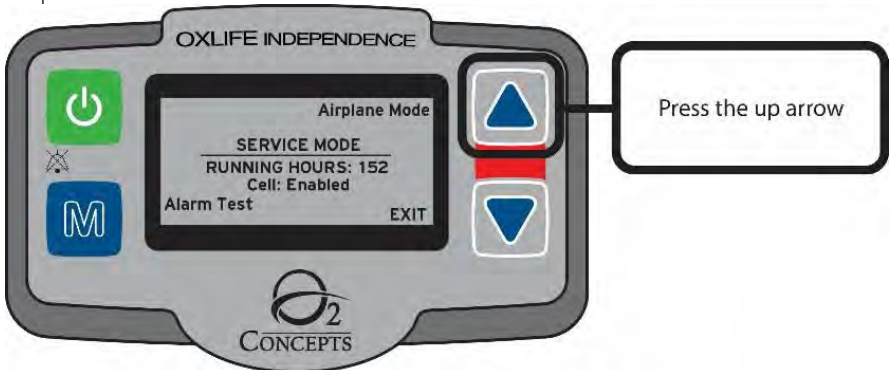

Press the Up Arrow Button (▲) in order to enter Airplane Mode. The mode listed in the upper right corner of the display is the mode that you will be entering.

Step 3:

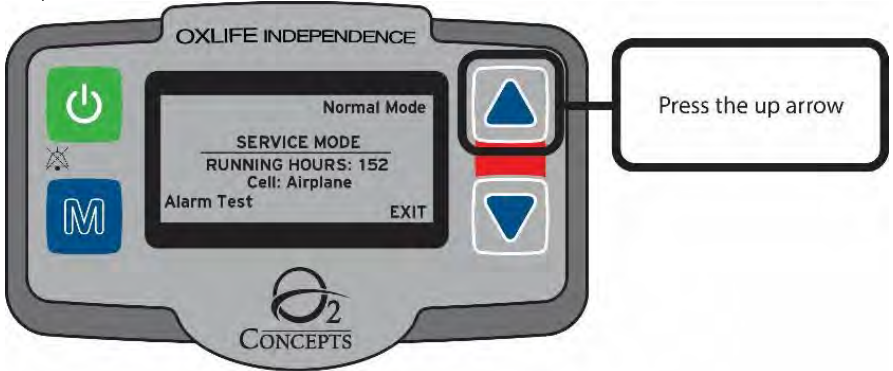

The unit will exit Airplane Mode after 24 hours have passed or the user manually re-enters Normal Mode. Press the Up Arrow Button (▲) again to enter Normal Mode.

Step 4:

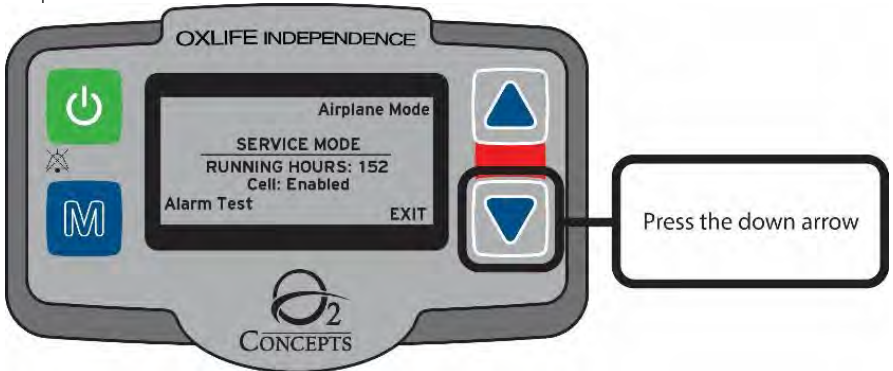

Press the Down Arrow Button (▼) in order to exit the service mode screen.

Accessing the Provider Screen and Changing Languages

The Provider Screen shows information about the status and language setting of the unit. Within the Provider Screen, the language of the device can be changed to six different languages, including English, German, Dutch, Spanish, French, and Italian.

Entering the Provider Screen:

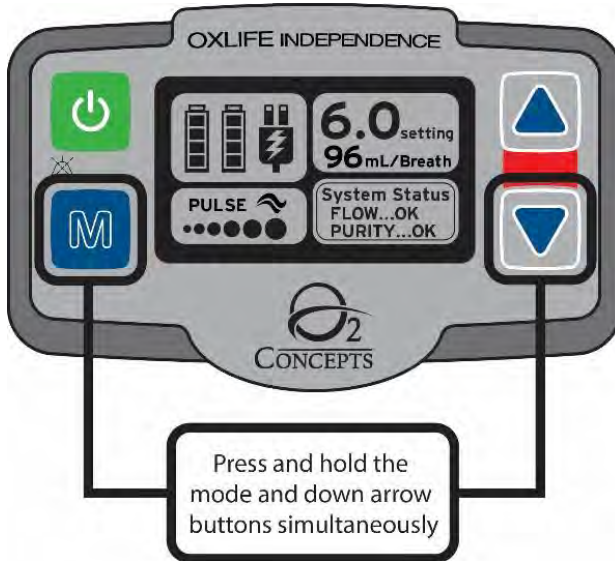

Press and hold the Mode Button (M) and Down Arrow Button (▼) simultaneously to enter the Provider Screen.

Changing Languages:

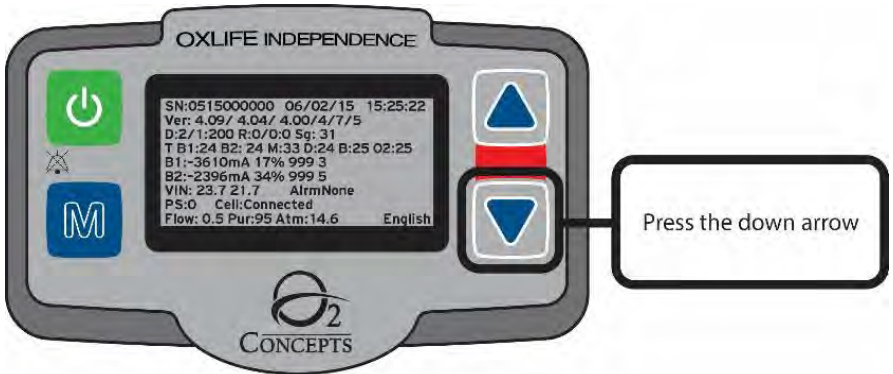

Inside the Provider Screen, the user can change the device language by pressing the Down Arrow Button (▼). The current language is displayed in the bottom right corner. The language changes each time the Down Arrow Button (▼) is pressed in the order shown below.

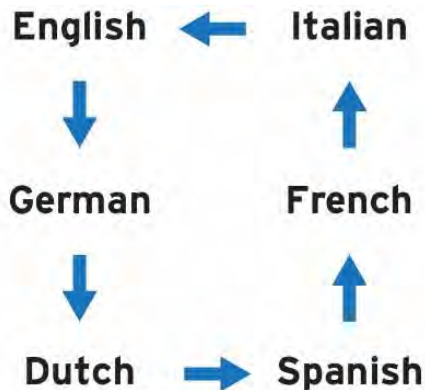

Cell Status and Signal Strength:

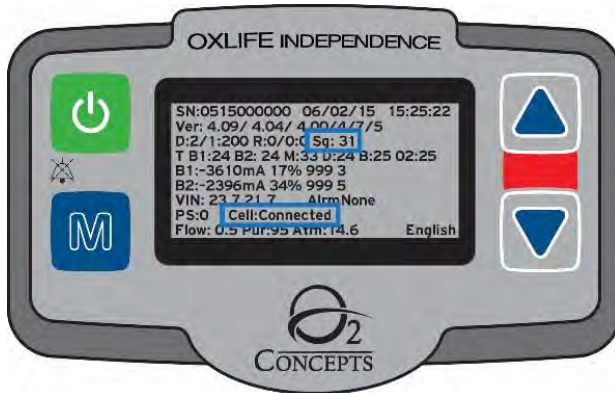

The cell signal strength is listed in the third row on a scale of 0 through 31 (ex. Sg:31). The cell status is listed in the eighth row (ex. Cell:Connected).

Voltage In:

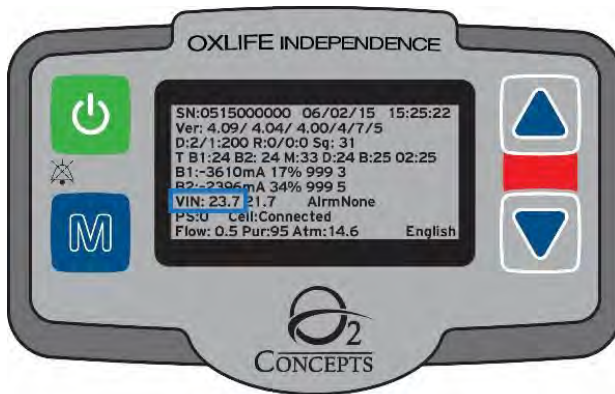

The voltage in is the voltage that the unit is receiving from an external power source, such as the AC power supply or DC power supply (ex. VIN: 23.7 where 23.7 is in volts).

Section 5: User Alerts and Alarms

The functionality of the alarm system is verified automatically by the unit upon start up by the unit flashing the various visual display colors and audible indicators. There are delays that are greater than 10 seconds inherent to specific alarms, and these delays are explained in detail for each alarm in the tables below.

Alarm and Alert Screens

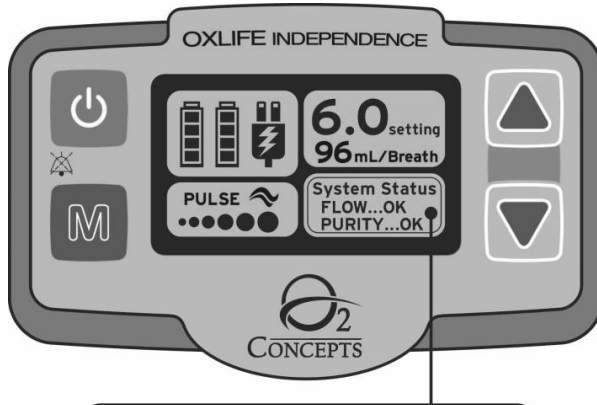

ALERTS AND ALARMS WILL BE INDICATED IN THE LOWER RIGHT CORNER OF THE LCD DISPLAY.

Red Screens

No Flow	No External Power
High External Power	Unauthorized Battery
Low Purity	Over Temperature
Low Battery	Invalid Motor Temperature
Low External Power	Invalid Box Temperature

Amber Screens

Low Purity
No Breath
Low Battery
Unauthorized Battery
Alert Low External Power

Alarm System Test

Use this test to verify that the alarm system is working properly. This test includes screen color, screen flashing sequence, and audible alarm sequence. Follow the steps in the procedure listed below.

Step 1:

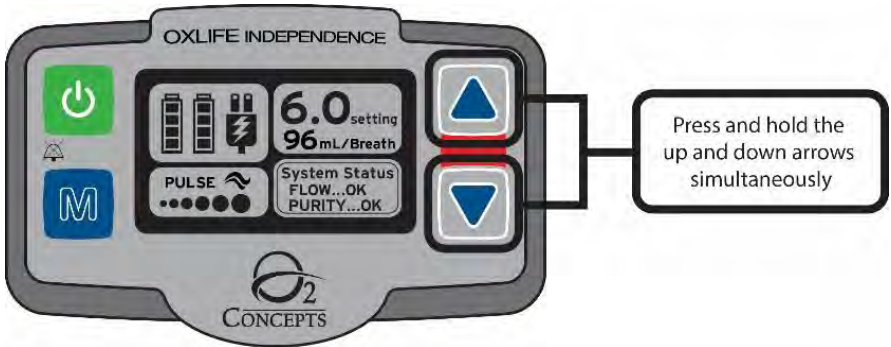

Press and hold both the Up Arrow Button (▲) and Down Arrow Button (▼) simultaneously in order to enter the Service Mode screen.

Step 2:

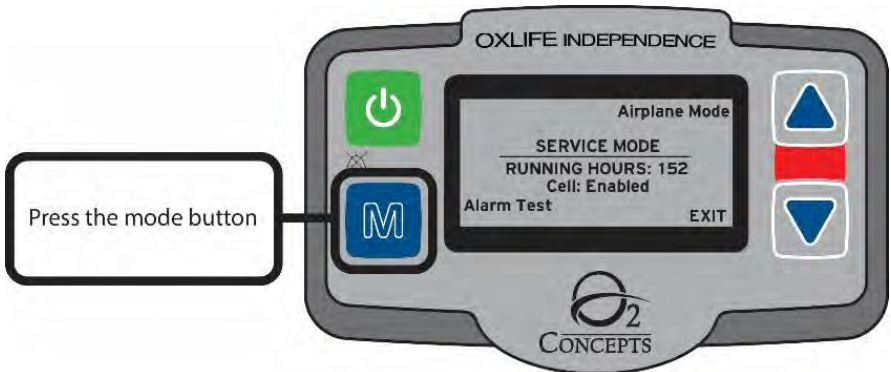

Press the Mode Button (M) to test the alarm system.

Step 3:



The system will begin by testing the High Priority Alarm. The High Priority Alarm consists of a 10 beep sequence separated by 2.5 seconds of silence, and the LCD screen flashes red.

Step 4:

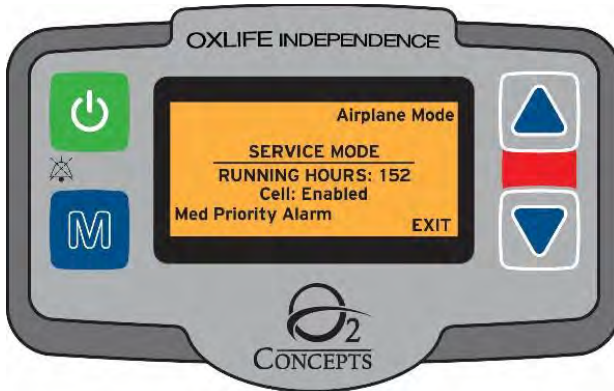

The unit will automatically enter the Medium Priority Alarm test once the High Priority Alarm sequence has concluded. Pressing the Mode Button (M) while the High Priority Alarm test is in progress will terminate the High Priority Alarm test and start the Medium Priority Alarm. The Medium Priority Alarm consists of a 3 beep sequence separated by 15 seconds of silence, and the LCD screen will flash amber.

Step 5:

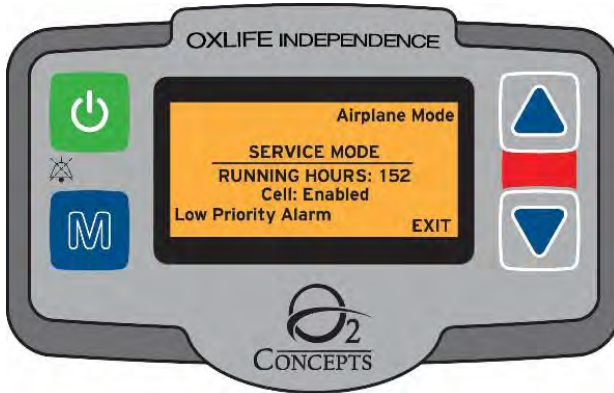

The unit will automatically enter the Low Priority Alarm test once the Medium Priority Alarm sequence has concluded. Pressing the Mode Button (M) while the Medium Priority Alarm test is in progress will terminate the Medium Priority Alarm test and start the Low Priority Alarm. The Low Priority Alarm consists of 1 beep and a solid amber LCD screen.

Step 6:

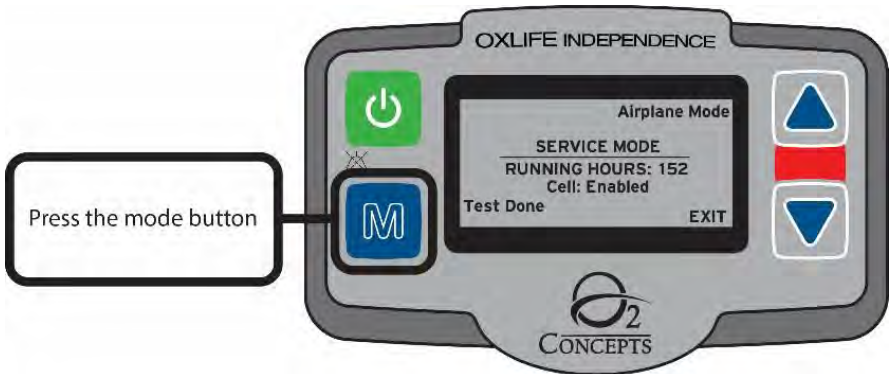

The screen will display Test Done after the Alarm System Test has concluded. Press the Mode Button (M) once to reset and complete the Alarm Test feature.

Step 7:

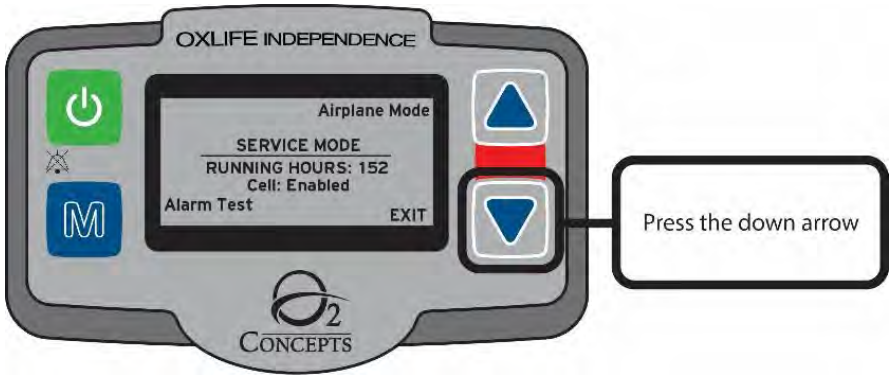

Press the Down Arrow Button (▼) in order to exit the Service Mode screen.

How to Simulate Alarms and Alerts (Providers Only)

Alarm Name, Priority and Type	Alarm Description	How to Simulate Alarm
<p style="text-align: center;">No Breath Alarm</p> <p style="text-align: center;">(Low Priority) (Physiological)</p>	<p>When in PULSE mode, if a breath is not detected for 45 seconds the screen will turn amber, sound one beep and the text "No Breath" will flash in the system status window.</p> <p>If no breath is detected for an additional 15 seconds, the unit will switch to the previous CONTINUOUS mode setting selected.</p>	<p>Run unit in PULSE mode with no cannula connected. Unit will automatically trigger alarm and revert to CONTINUOUS mode.</p>
<p style="text-align: center;">Low Battery Alert</p> <p style="text-align: center;">(Low Priority) (Technical)</p>	<p>When calculated battery run time reaches 6 minutes remaining the screen will turn amber, sound one beep per 30 seconds and the text "Low Battery" will flash in the system status window.</p> <p>Pushing POWER button once silences the beeping.</p>	<p>Run unit in CONTINUOUS mode 2.0 with one low charge battery. Unit will alarm with 6 minutes of run time remaining.</p>
<p style="text-align: center;">Low Battery Alarm</p> <p style="text-align: center;">(High Priority) (Technical)</p>	<p>When battery power is depleted, the pump shuts off the screen will flash red at 2Hz, sound a 10 beep sequence repeated after 2.5 seconds of silence and the text "Low Battery" will flash in the system status window</p> <p>The unit will continue to sound until; the power button is pressed to silence the audio, the power button is held to power off the unit, or 15 seconds has expired.</p>	<p>Run unit in CONTINUOUS mode 2.0 with a low charge battery. Allow unit to enter battery alert mode, then alarm mode.</p>
<p style="text-align: center;">Low Purity Alert</p> <p style="text-align: center;">(Low Priority) (Technical)</p>	<p>When oxygen levels drop below 85%, the screen will turn amber, sound one beep per 30 seconds and the text "Low Purity" will flash in the system status window.</p> <p>Pushing POWER button once silences the beeping.</p>	<p>Introduce a nitrogen rich stream of gas to the inlet port of the enclosure. Oxygen purity should fall when unit is deprived of "clean" air.</p>
<p style="text-align: center;">Low Purity Alarm</p> <p style="text-align: center;">(High Priority) (Technical)</p>	<p>When oxygen levels drop below 72%, the screen will flash red at 2Hz, sound a 10 beep sequence repeated after 2.5 seconds of silence and the text "Low Purity" will flash in the system status window</p> <p>The unit will continue to sound until; the power button is pressed to silence the audio, the power button is held to power</p>	<p>Introduce a nitrogen rich stream of gas to the inlet port of the enclosure. Oxygen purity should fall when unit is deprived of "clean" air.</p>

Alarm Name, Priority and Type	Alarm Description	How to Simulate Alarm
	off the unit, or 15 seconds has expired.	
No Flow Alarm (High Priority) (Technical)	When the flow of oxygen is stopped for 45 seconds, the screen will flash red at 2Hz, sound a 10 beep sequence repeated after 2.5 seconds of silence and the text "No Flow" will flash in the system status window The unit will continue to sound until; the power button is pressed to silence the audio, the power button is held to power off the unit, or 15 seconds has expired.	Run the unit in 2.0 Continuous and allow it to warm up. Place a cap over the outlet of the unit and wait the appropriate amount of time.
Over Temperature Alarm (High Priority) (Technical)	The maximum operating temperature of the enclosure and pump is 70°C and 90°C respectively. When either of these temperatures are reached the screen will flash red at 2Hz, sound a 10 beep sequence repeated after 2.5 seconds of silence and the text "Over Temperature" will flash in the system status window The unit will continue to sound until; the power button is pressed to silence the audio, the power button is held to power off the unit, or 15 seconds has expired.	Remove display circuit board and associated sheet metal. Apply heat from a heat gun gradually to thermistor located on board until unit alarms. Sensor output can be monitored in "engineering mode" of device in real time.
Invalid Motor Temperature (High Priority) (Technical)	When the motor temperature sensor is out of a valid range, the screen will flash red at 2Hz, sound a 10 beep sequence repeated after 2.5 seconds of silence and the text "Invalid Motor Temperature" will flash in the system status window The unit will continue to sound until; the power button is pressed to silence the audio, the power button is held to power off the unit, or 15 seconds has expired.	Disconnect the temp wires on the motor hall sensor cable (2 purple wires)
Invalid Box Temperature (High Priority) (Technical)	When the internal box temperature sensor is out of a valid range, the screen will flash red at 2Hz, sound a 10 beep sequence repeated after 2.5 seconds of silence and the text "Invalid Box Temperature" will flash in the system status window The unit will continue to sound until; the power button is pressed to silence the audio, the power button is held to power off the unit, or 15 seconds has expired.	Chill the unit to 34 deg F while off then turn on while still cold
Unauthorized Battery Alert	If the unit detects that a battery other than one from O2 Concepts has been installed in the unit the battery icon will show an exclamation point within the battery	Install a battery from a manufacturer other than O2 Concepts while another power source is

Alarm Name, Priority and Type	Alarm Description	How to Simulate Alarm
(Medium Priority) (Technical)	outline. The unit will continue to run if on AC, DC or a second valid battery is present. The screen will turn amber, sound a 3 beep sequence repeated after 15 seconds of silence and the text "Unauthorized Battery" will flash in the system status window. Pushing POWER button once silences the beeping.	present.
Unauthorized Battery Alarm (High Priority) (Technical)	If the unit detects that a battery other than one from O2 Concepts has been installed in the unit the battery icon will show an exclamation point within the battery outline. If no other power source is present the screen will flash red at 2Hz, sound a 10 beep sequence repeated after 2.5 seconds of silence and the text "Unauthorized Battery" will flash in the system status window The unit will continue to sound until; the power button is pressed to silence the audio, the power button is held to power off the unit, or 15 seconds has expired.	Install a battery from a manufacturer other than O2 Concepts with no other power source present.
Low External Power Alert (Medium Priority) (Technical)	When the voltage from an external power source falls to 11.6 volts or less (as measured by the unit internally) the screen will turn amber, sound a 3 beep sequence separated by 15 seconds of silence and the text "Low External Power" will flash in the system status window. Pushing POWER button once silences the beeping.	Connect to an external DC power supply capable of delivering 20amps. Run unit on 2.0 continuous. Starting at 14 volts steadily reduce input voltage until unit alerts.
Low External Power Alarm (High Priority) (Technical)	When the voltage from an external power source falls below 10.6 volts (as measured by the unit internally) the screen will flash red at 2Hz, sound a 10 beep sequence repeated after 2.5 seconds of silence and the text "Low External Power" will flash in the system status window The unit will continue to sound until; the power button is pressed to silence the audio, the power button is held to power off the unit, or 15 seconds has expired.	Connect to an external DC power supply capable of delivering 20amps. Run unit on 2.0 continuous. Starting at 14 volts steadily reduce input voltage until unit alarms.
High External Power Alarm	When the voltage from an external power source is above 26 volts (as measured by	Connect to an external DC power supply capable of delivering

Alarm Name, Priority and Type	Alarm Description	How to Simulate Alarm
(High Priority) (Technical)	<p>the unit internally) the screen will flash red at 2Hz, sound a 10 beep sequence repeated after 2.5 seconds of silence and the text "High External Power" will flash in the system status window</p> <p>The unit will continue to sound until: the power button is pressed to silence the audio, the power button is held to power off the unit, or 15 seconds has expired.</p>	20amps. Run unit on 2.0 continuous. Starting at 14 volts steadily increase input voltage until unit alarms.
No External Power Alarm (High Priority) (Technical)	<p>If power is removed while the unit is running the unit will sound a 10 beep sequence repeated after 4 seconds of silence.</p> <p>Since the power is removed, the display is blank and no backlight color is available.</p>	Run unit on 2.0 continuous using AC power supply. Remove all batteries. Remove AC power supply.

DO NOT IGNORE ALARMS

How to Respond to Alarms

Alarm Name, Priority and Type	Alarm Description	Solution
<p style="text-align: center;">No Breath Alarm</p> <p style="text-align: center;">(Low Priority) (Physiological)</p>	<p>When in PULSE mode, if a breath is not detected for 45 seconds the screen will turn amber, sound one beep and the text "No Breath" will flash in the system status window.</p> <p>If no breath is detected for an additional 15 seconds, the unit will switch to the previous CONTINUOUS mode setting selected.</p>	<p>Ensure cannula tubing does not exceed 7 feet (2.1m). Ensure user breathing through nose and not mouth. Note: No Breath Detected is used when in Pulse Flow Mode ONLY.</p>
<p style="text-align: center;">Low Battery Alert</p> <p style="text-align: center;">(Low Priority) (Technical)</p>	<p>When calculated battery run time reaches 6 minutes the screen will turn amber, sound one beep per 30 seconds and the text "Low Battery" will flash in the system status window.</p> <p>Pushing POWER button once silences the beeping.</p>	<p>Plug into an external power source. OR Replace depleted battery (batteries) with a charged battery.</p>
<p style="text-align: center;">Low Battery Alarm</p> <p style="text-align: center;">(High Priority) (Technical)</p>	<p>When battery power is depleted, the pump shuts off, the screen will flash red at 2Hz, sound a 10 beep sequence repeated after 2.5 seconds of silence and the text "Low Battery" will flash in the system status window</p> <p>The unit will continue to sound until: the power button is pressed to silence the audio, the power button is held to power off the unit, or 15 seconds has expired.</p>	<p>Plug into an external power source. Replace depleted battery (batteries) with a charged battery.</p>
<p style="text-align: center;">Low Purity Alert</p> <p style="text-align: center;">(Low Priority) (Technical)</p>	<p>When oxygen levels drop below 85% the screen will turn amber, sound one beep per 30 seconds and the text "Low Purity" will flash in the system status window.</p> <p>Pushing POWER button once silences the beeping.</p>	<p>Clean or replace air inlet filter. Contact your authorized dealer.</p>
<p style="text-align: center;">Low Purity Alarm</p> <p style="text-align: center;">(High Priority) (Technical)</p>	<p>When oxygen levels drop below 72% the screen will flash red at 2Hz, sound a 10 beep sequence repeated after 2.5 seconds of silence and the text "Low Purity" will flash in the system status window</p> <p>The unit will continue to sound until: the power button is pressed to silence the audio, the power button is held to power off the unit, or 15 seconds has expired.</p>	<p>Repair or replace tubing or humidifier. Clean or replace air inlet filter. Contact your authorized dealer.</p>
<p style="text-align: center;">No Flow Alarm</p>	<p>When the flow of oxygen is stopped for 45</p>	<p>Check cannula connection. Repair or</p>

Alarm Name, Priority and Type	Alarm Description	Solution
(High Priority) (Technical)	seconds the screen will flash red at 2Hz, sound a 10 beep sequence repeated after 2.5 seconds of silence and the text "No Flow" will flash in the system status window The unit will continue to sound until: the power button is pressed to silence the audio, the power button is held to power off the unit, or 15 seconds has expired.	replace tubing or humidifier. Clean or replace air inlet filter. Move device to ensure adequate air flow. Contact your authorized dealer.
Over Temperature Alarm (High Priority) (Technical)	The maximum operating temperature of the enclosure and pump is 70°C and 90°C respectively. When either of these temperatures are reached the screen will flash red at 2Hz, sound a 10 beep sequence repeated after 2.5 seconds of silence and the text "Over Temperature" will flash in the system status window The unit will continue to sound until: the power button is pressed to silence the audio, the power button is held to power off the unit, or 15 seconds has expired.	Allow the device to reach operating temperature. Utilize an alternate source of oxygen if necessary.
Invalid Motor Temperature (High Priority) (Technical)	When the motor temperature sensor is out of a valid range the screen will flash red at 2Hz, sound a 10 beep sequence repeated after 2.5 seconds of silence and the text "Invalid Motor Temperature" will flash in the system status window The unit will continue to sound until: the power button is pressed to silence the audio, the power button is held to power off the unit, or 15 seconds has expired.	Allow the device to reach operating temperature. Utilize an alternate source of oxygen if necessary.
Invalid Box Temperature (High Priority) (Technical)	When the internal box temperature sensor is out of a valid range the screen will flash red at 2Hz, sound a 10 beep sequence repeated after 2.5 seconds of silence and the text "Invalid Box Temperature" will flash in the system status window The unit will continue to sound until: the power button is pressed to silence the audio, the power button is held to power off the unit, or 15 seconds has expired.	Allow the device to reach operating temperature. Utilize an alternate source of oxygen if necessary.
Unauthorized Battery Alert (Medium)	If the unit detects that a battery other than one from O2 Concepts has been installed in the unit the battery icon will show an exclamation point within the	Remove unauthorized battery and replace with an authorized O2 Concepts battery.

Alarm Name, Priority and Type	Alarm Description	Solution
Priority) (Technical)	<p>battery outline. The unit will continue to run if on AC, DC or a second valid battery is present. The screen will turn amber, sound a 3 beep sequence repeated after 15 seconds of silence and the text "Unauthorized Battery" will flash in the system status window.</p> <p>Pushing POWER button once silences the beeping.</p>	
Unauthorized Battery Alarm (High Priority) (Technical)	<p>If the unit detects that a battery other than one from O2 Concepts has been installed in the unit the battery icon will show an exclamation point within the battery outline. If no other power source is present, the screen will flash red at 2Hz, sound a 10 beep sequence repeated after 2.5 seconds of silence and the text "Unauthorized Battery" will flash in the system status window</p> <p>The unit will continue to sound until: the power button is pressed to silence the audio, the power button is held to power off the unit, or 15 seconds has expired.</p>	Remove unauthorized battery and replace with an authorized O2 Concepts battery.
Low External Power Alert (Medium Priority) (Technical)	<p>When the voltage from an external power source falls to 11.6 volts or less (as measured by the unit internally) the screen will turn amber, sound a 3 beep sequence separated by 15 seconds of silence and the text "Low External Power" will flash in the system status window.</p> <p>Pushing POWER button once silences the beeping.</p>	Ensure all charging connections are intact. Refer to the DC user guide section of this manual.
Low External Power Alarm (High Priority) (Technical)	<p>When the voltage from an external power source falls below 10.6 volts (as measured by the unit internally) the screen will flash red at 2Hz, sound a 10 beep sequence repeated after 2.5 seconds of silence and the text "Low External Power" will flash in the system status window</p> <p>The unit will continue to sound until: the power button is pressed to silence the audio, the power button is held to power off the unit, or 15 seconds has expired.</p>	Ensure all charging connections are intact. Refer to the DC user guide section of this manual.
High External	When the voltage from an external	Disconnect the external power source from the

Alarm Name, Priority and Type	Alarm Description	Solution
Power Alarm (High Priority) (Technical)	<p>power source is above 26 volts (as measured by the unit internally) the screen will flash red at 2Hz, sound a 10 beep sequence repeated after 2.5 seconds of silence and the text "High External Power" will flash in the system status window</p> <p>The unit will continue to sound until: the power button is pressed to silence the audio, the power button is held to power off the unit, or 15 seconds has expired.</p>	Oxlife Independence and use an alternative power source that is within the operating limits.
No External Power Alarm (High Priority) (Technical)	<p>If power is removed while the unit is running the unit will sound a 10 beep sequence repeated after 4 seconds of silence.</p> <p>Since the power is removed, the display is blank and no backlight color is available.</p>	Ensure all charging connections are intact. In the case of an extended power outage, utilize an alternate, non-powered, source of oxygen.





Section 6: Maintenance and Cleaning

Maintenance

All maintenance **MUST** be conducted by a qualified Oxlife Independence service technician. **DO NOT** attempt to disassemble or perform any maintenance on your device. Any such attempt will void the warranty.

Routine cleaning of the air inlet filter, as described below, is the only routine maintenance. The Oxlife Independence and its parts requires maintenance at the end of the 5 year service life or as required, determined by your care provider. There is no routine maintenance or service to the O2 Concepts rechargeable batteries.

User Care and Cleaning

-  Unplug your Oxlife Independence and or power supplies before cleaning.
-  **DO NOT** use alcohol, ethylene chloride or petroleum based cleaners on the case or power supplies.
-  Clean the outside case of your device using a soft cloth dampened with a mild detergent and water.
-  **DO NOT** spray or soak the case or front panel.

Air Inlet Filter Cleaning

Regular cleaning of the Air Inlet Filter is the only maintenance you will perform on your device. To keep your Oxlife Independence working properly, it is recommended you clean the Air Inlet Filter weekly.

If the Oxlife Independence is used in a dusty environment, more frequent cleaning of the Air Inlet Filter may be required.

Never use your Oxlife Independence without an Air Inlet Filter.

Air Inlet Filter Cleaning (Continued)

Follow these simple directions to clean the Air Inlet Filter:

1. Remove the Air Inlet Filter
 2. Wash the filter by running under warm tap water using a mild detergent.
 3. Rinse thoroughly under warm, running water.
 4. Squeeze out excess water.
 5. It is important to allow the filter to dry completely before reinserting into the device. Moisture from a wet or damp Air Inlet Filter may damage your device.
- ⚠ You may want to keep an extra Air Inlet Filter to use as a replacement while one is drying.

Contact your authorized dealer for extra Air Inlet Filters.

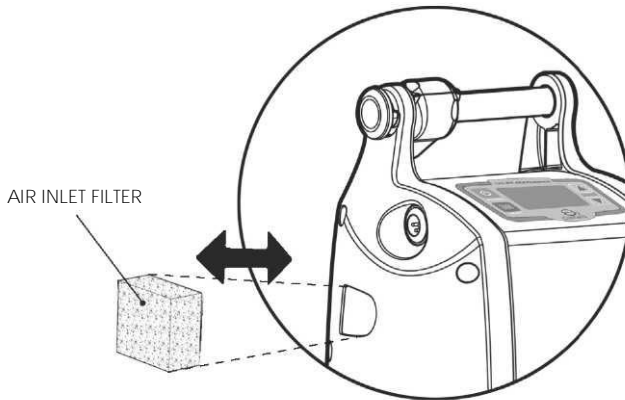

Battery Disposal

Your battery is rechargeable and can be recycled. Always return to your authorized dealer for proper disposal. You can also contact your local city or town offices for proper disposal instructions for a lithium ion battery.

Device Disposal

This product may contain substances that could be harmful to the environment if disposed of in landfills that are inappropriate. Follow local governing ordinances and recycling plans regarding disposal of the device.

Section 7: Standards Compliance

This device is designed to comply with the following standards:

- ISO 8359 2nd Edition; Oxygen Concentrators for Medical Use – Safety Requirements
- RTCA, DO 160, Section 21, Category M; Emission of Radio Frequency Energy
- ISO 13485:2003 Medical Devices; Quality Management Systems; Requirements for Regulatory Purposes

NOTES

Oxlife INDEPENDENCE

O2 Concepts LLC

199 Park Road Extension, Middlebury, CT 06762

(877) 867-4008

www.o2-concepts.com



PN: 800-1029 Rev B

10.26.2016